

Arica

arica



A stylish brushed and lacquered tubular 316 grade stainless steel bollard, available in a wide range of lamp technologies, including high pressure sodium (SON), metal halide and compact fluorescent. A choice of round or flat top design with options of either flat 316 grade stainless steel louvres c/w clear polycarbonate diffuser, conical white aluminium louvres c/w clear polycarbonate diffuser and opal polycarbonate diffuser (no louvres). Suitable for car parks, docks, walkways, driveways and entrances/approaches to a variety of buildings

- Low light pollution
- Various louvre and diffuser options
- Wide range of lamp technologies
- Flat or round top designs
- Simple re-lamping capability
- Root-mount or flange installation
- Interchangeable control gear

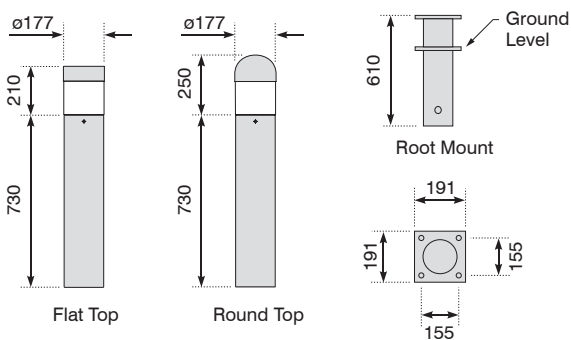

SPECIFICATION

To specify state the following:

Robust brushed and lacquered tubular 316 grade stainless steel bollard, available with high pressure sodium (SON), metal halide and compact fluorescent lamp technologies. Choice of round or flat top design with options of flat 316 grade stainless steel louvres c/w clear polycarbonate diffuser, conical white aluminium louvre c/w clear polycarbonate diffuser and opal polycarbonate diffuser (no louvre). Root and flange mounting options available. Heads are secured with 3 stainless steel bolts, hex head as standard and optional tamperproof.

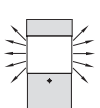

Opal polycarbonate diffuser, no louvre

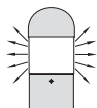

Flat stainless steel louvre, clear polycarbonate diffuser

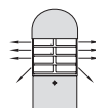

Conical white aluminium louvre, clear polycarbonate diffuser

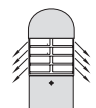

RAMGroup UK

www.rampost.co.uk

Unit 1A, Levens Road, Newby Road Industrial Estate, Hazel Grove, Stockport, SK7 5DL

Tel: 0161 482 4001 Fax: 0161 482 4041 E-mail: ramgroup@btconnect.com



Photometry

Average Principal Axes Luminous Intensities (Cd/klm)

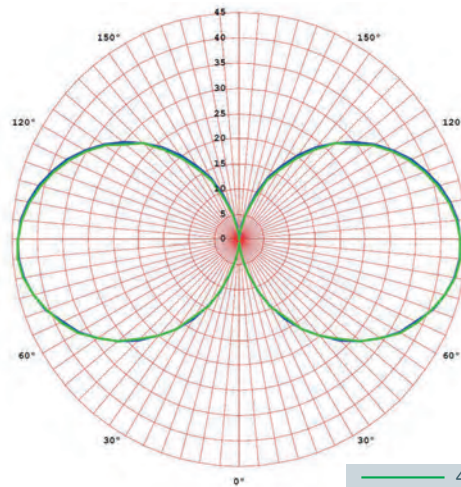

Product Code: BA93NOH35TL
Lamp: 35W Ceramic metal halide
Light Output Ratios: Up: 0.20 Down: 0.21 Total: 0.40

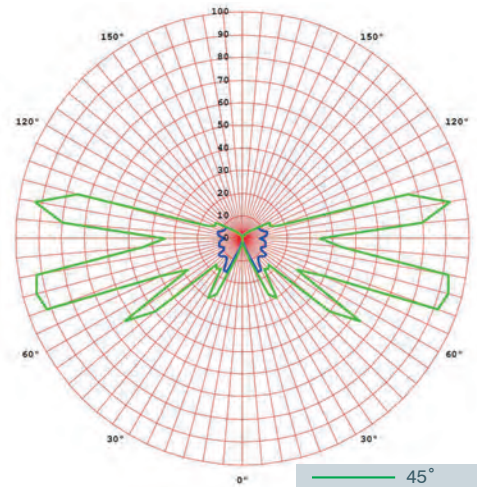

Product Code: BA93SH35TL
Lamp: 35W Ceramic metal halide
Light Output Ratios: Up: 0.17 Down: 0.26 Total: 0.43

Materials and Design

1.80mm brushed and lacquered tubular 316 grade stainless steel. Heads available with a choice of either flat 316 grade stainless steel louvres and clear polycarbonate diffuser, conical white aluminium louvres and clear polycarbonate diffuser or opal polycarbonate diffuser (no louvres). The root mount is fabricated from 3.50mm galvanised steel tube.

Installation

The Arica can be either flange or root mounted (root mounting requires the galvanised steel root mount to be set in concrete). The gear tray is affixed inside the tubular body of the bollard with the head secured on top of the body. The heads are secured to the tubular body with 3 stainless steel bolts, hex head countersunk socket screws as standard and optional tamperproof.

Electrical

Cable entry to the bollard is through the base/root. Electrical connections are made to a 3-way polyamide screwed terminal strip mounted on the gear tray. A fused screwed terminal strip can be provided on request.

Classification for Protection and Standards

Against electric shock Class 1 protected with earthed metalwork. It is important that this product is electrically installed according to the relevant IEE Regulations. Against ingress of dust and moisture IP65 Technical Specification. The Arica range of luminaires is designed and manufactured to meet the requirements of BSEN 60598 2-1.

Note: Care must be taken in the way your fitting is intalled otherwise this may adversely effect its IP rating.

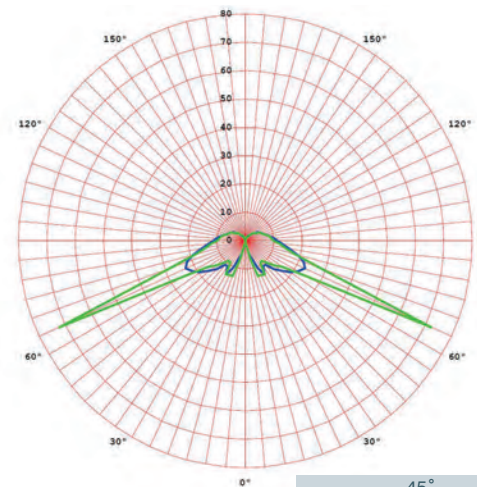

Product Code: BA93AWH35TL
Lamp: 35W Ceramic metal halide
Light Output Ratios: Up: 0.03 Down: 0.12 Total: 0.16

Wattage	Description	Code
26W	Compact fluoresecent fitting c/w switch-start gear & lamp, white aluminium louvres & clear polycarbonate diffuser, flat top cap, root mounted	BA93AW26L
35W	Metal halide fitting c/w intergral gear, timed ignitor, lamp (E27), white aluminium louvres & clear polycarbonate diffuser, flat top cap, root mounted	BA93AWH35TL
50W	SON fitting c/w intergral gear timed ignitor, lamp (E27), white aluminium louvres & clear polycarbonate diffuser, flat top cap, root mounted	BA93AWS0TL
-	Dummy fitting, no gear or louvres c/w opal polycarbonate diffuser, flat top cap, root mounted	BA93NO

Notes:

All above codes are for root mounted Arica's white aluminium louvres c/w clear polycarbonate diffuser and flat top head.

For the stainless steel louvre version replace 'AW' with 'S' in the above product code. e.g. BA93AW26L = BA93S26L

For the opal polycarbonate diffuser no louvres version replace 'AW' with 'NO' in the above product code. e.g. BA93AW26L = BA93NO26L

For flange mounted versions place 'F' after the '3' in the above product code. e.g. BA93AW26L = BA93FAW26L

For round top versions place 'R' after 'A' in the above product code. e.g. BA93AW26L = BAR93AW26L

ACCESSORIES

- Stainless steel, tamperproof securing bolts.