

PRODUCT SPECIFICATION

RAM 312

- Material: Grade 250 Cast Iron
- Standard Finish: One Coat Williamsons Metal Primer. One Coat Dulux Weathershield Rust Resistant Paint System applied in most RAL or BS colours
- We can supply tree grilles with irrigation holes and covers in order to give access to the irrigation of the tree root system. Other products relating to irrigation are available on request
- Tree Grilles can be supplied with a range of supporting frames depending up to the application: Light, Medium or Heavy Duty Paving Support
- RAM offer a large range of tree guards which fix directly to the supporting frames to provide an extremely rigid and effective method of tree protection. See our section on Tree Guards
- Security Clips are available to prevent unauthorised removal of the tree grille segments and to further increase the systems rigidity

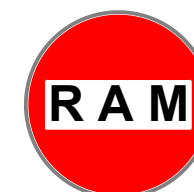
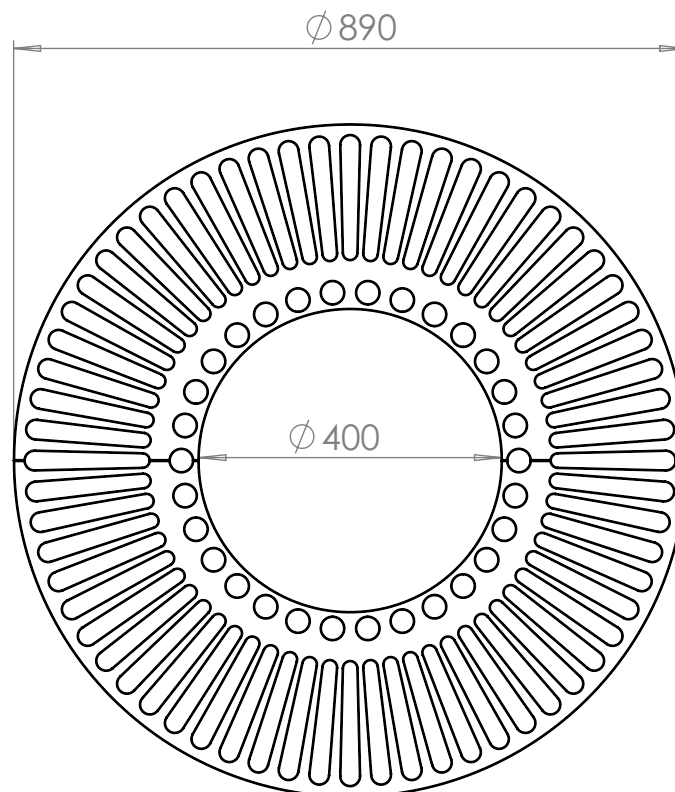

RAMGroup UK

RAM Group UK
Head Office
Newby Road Industrial Estate
Hazel Grove
Stockport
SK7 5DL

Tel: +44 (0)161 482 4001
Fax: +44 (0)161 482 4041
Email: ramgroup@btconnect.com