

PRODUCT SPECIFICATION

RAMCAST-106

- Grade 250 Cast Iron
- Williamsons Metal Primer
- Dulux weathershield rust resistant paint system applied in most RAL or BS colours
- Rings, Logos etc can be embellished in Weathershield Gold to provide contrast
- Bollards supplied in Fixed Version as Standard, Removable, Fold Down or Trough fold down available on request
- Reflective bands can be applied in white, red or yellow
- Internal Thick Walled Steel Sleeves can be used to provide additional ram raid resistance
- Logos, Emblems, Coats of Arms etc can be cast onto the side of the bollards on request

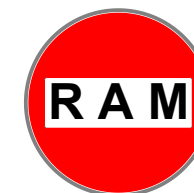
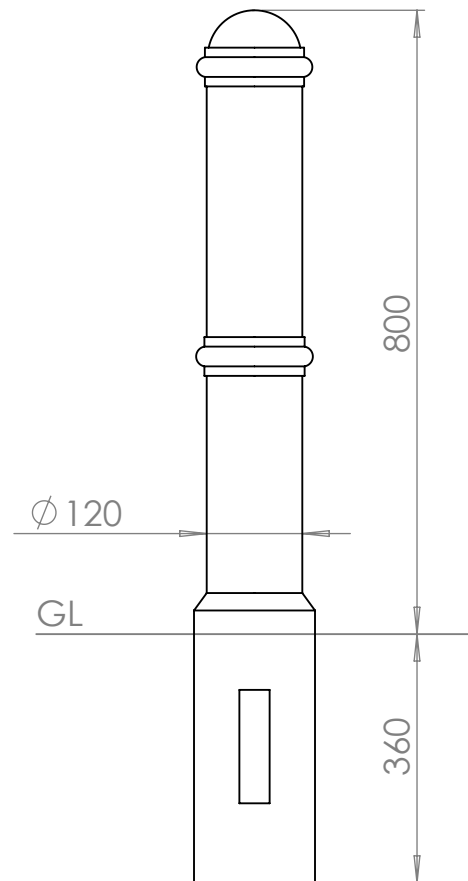

RAMGroup UK

RAM Group UK
Head Office
Newby Road Industrial Estate
Hazel Grove
Stockport
SK7 5DL

Tel: +44 (0)161 482 4001
Fax: +44 (0)161 482 4041
Email: ramgroup@btconnect.com