

## PRODUCT SPECIFICATION

### RAMCAST-107

- Grade 250 Cast Iron
- Williamsons Metal Primer
- Dulux weathershield rust resistant paint system applied in most RAL or BS colours
- Rings, Logos etc can be embellished in Weathershield Gold to provide contrast
- Bollards supplied in Fixed Version as Standard, Removable, Fold Down or Trough fold down available on request
- Reflective bands can be applied in white, red or yellow
- Internal Thick Walled Steel Sleeves can be used to provide additional ram raid resistance
- Logos, Emblems, Coats of Arms etc can be cast onto the side of the bollards on request

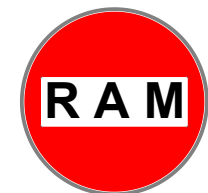
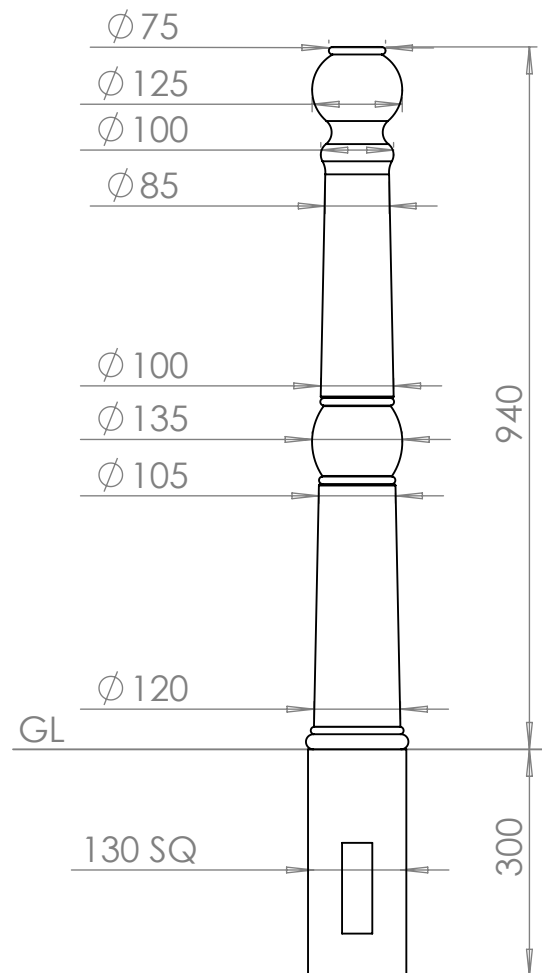

**RAMGroup UK**

RAM Group UK  
Head Office  
Newby Road Industrial Estate  
Hazel Grove  
Stockport  
SK7 5DL

Tel: +44 (0)161 482 4001  
Fax: +44 (0)161 482 4041  
Email: ramgroup@btconnect.com